

Ø 14-32 mm



KAN-therm SYSTEM

Push Platinum

Reliability and Prestige

EN 2015



TECHNOLOGY OF SUCCESS



ISO 9001



About KAN

Innovative water and heating solutions

KAN was established in 1990 and has been implementing state of the art technologies in heating and water distribution solutions ever since.

KAN is a European recognized leader and supplier of state of the art KAN-therm solutions and installations intended for indoor hot and cold tap water installations, central heating and floor heating installations, as well as fire extinguishing and technological installations. Since the beginning of its activity, KAN has been building its leading position on such values as professionalism, innovativeness, quality and development. Today, the company employs over 600 people, a great part of which are specialist engineers responsible for ensuring continuous development of the KAN-therm system, all technological processes applied and customerservice. The qualifications and commitment of our personnel guarantees the highest quality of products manufactured in KAN factories.

Distribution of the KAN-therm system is performed through a network of commercial partners all over Poland, Germany, Russia, Ukraine, Belarus, Ireland, the Czech Republic, Slovakia, Hungary, Romania and in the Baltic States. Our expansion and dynamic development has proven so effective that KAN-therm labeled products are exported to 23 countries, and our distribution network assumes Europe, a great part of Asia, and a part of Africa.

The KAN-therm system is an optimal, complete multipurpose installation system consisting of state of the art, mutually complementary technical solutions for pipe water distribution installations, heating installations, as well as technological and fire extinguishing installations. It is the materialization of a vision of a universal system, the fruit of extensive experience, the passion of KAN's constructors, as well as strict quality control of our materials and final products.



SYSTEM KAN-therm
- special award:
Pearl of the highest quality
and:
Golden Quality International Medal
2015, 2014 i 2013.

TECHNOLOGY OF SUCCESS



Table of Contents

3	KAN-therm System Push Platinum
4	Advantages
5	Application
6	Pipes
7	Fittings
8	Tools
9	Installation
10	Durability
11	Additional Information

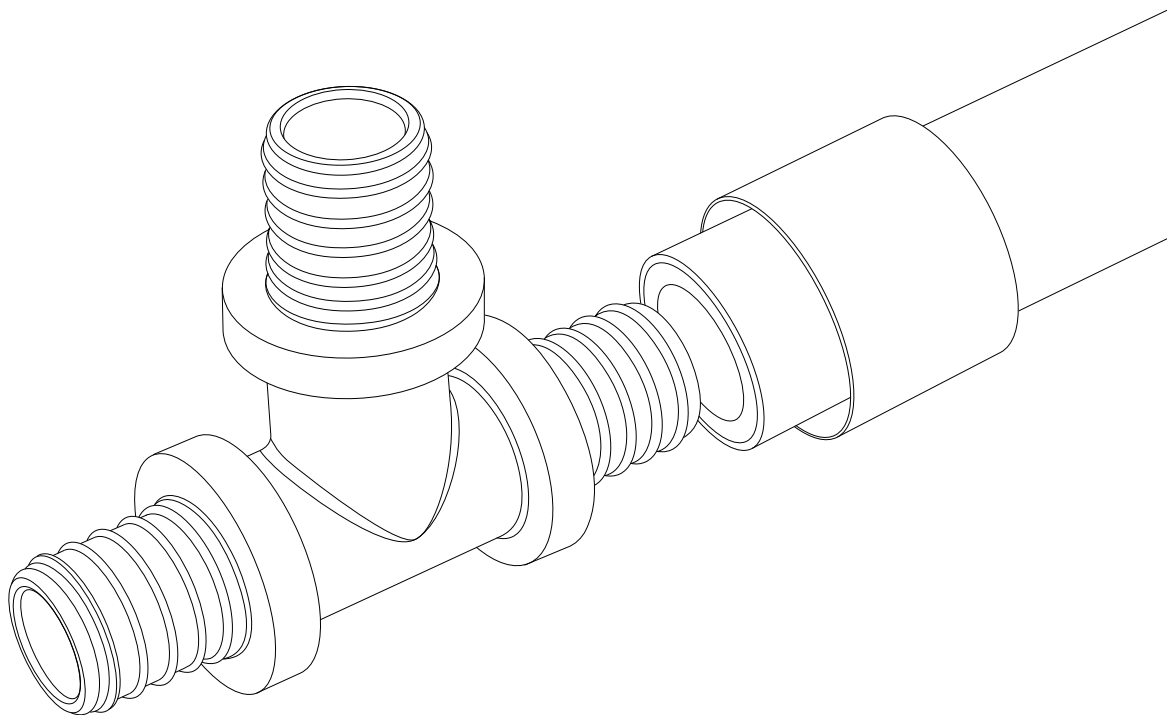

KAN-therm SYSTEM

Push Platinum

KAN-therm Push Platinum is a complete plastic installation system designed to build internal heating or water systems, using a sure, safe and quick installation technique based on pulling a brass ring on to the fitting's body. Its major advantage is its error-resistant connection system without any o-rings.

KAN-therm Push Platinum is ideal for the construction of new and renovation of existing internal central heating, radiant heating/cooling (floors, walls) systems, and hot and cold water systems.

Due to the material characteristics and the range of diameters, the system is perfectly suitable for piping systems in single-family houses. It can be successfully applied in multi-family housing and public facilities.

Advantages

— Safety and security

The only installation system on the market with a material warranty of up to 15 years covering all components: pipes and fittings.

— Reliability

Reliability provided by the unique KAN-therm Push & Seal™ solution, a self-sealing connection without additional o-rings in the design of the fittings.

— Durability

Proven by the KAN-therm T50™ test, simulating 50 years of operation, carried out in the modern international KAN certification lab.

— Convenient installation

With the composite structure of Platinum pipes, utilizing aluminum inserts, you can profile pipeline routes any way you like. The pipe does not have the "shape memory", which allows you to give it desired shape.

— Versatility and compatibility

The components' resistance to high temperatures and pressure makes it possible to use it in any type of installation. Fittings can be combined with composite Platinum pipes (with external aluminum) as well as homogenous PE-Xc and PE-RT pipes with a diffusion cover.

— Minimized pressure loss

The expanded pipe end minimizes diameter narrowing, which results in lowered pressure loss at the connection between the pipe and the fitting, ensuring the optimal flow of the medium throughout the system.

— Health and ecology

The materials used to manufacture the system components are physiologically and microbiologically neutral in drinking water installations; they are friendly to the environment and to health - PZH-approved.

— Resistance to assembly errors

The universal design of couplings, lack of additional seals in the structure of fittings, simple installation technique and the use of professional and user-friendly tools minimize the possibility of installation errors.

— Flush installation

Ability to install in floors and walls (under plaster).

— Latest technologies in manufacturing

The production process involves the latest, most effective, and above all, the safest methods of improving the strength of Platinum pipes by cross-linking them using the "c" physical method. This means bombarding the pipes with electron beams - without using additional chemicals.

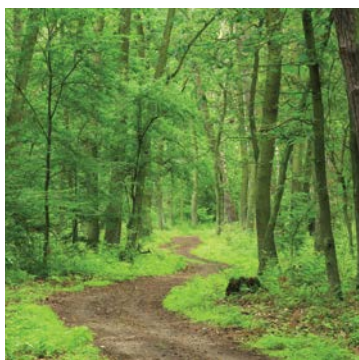

Application



The system is designed to build internal heating, cooling and domestic hot and cold water systems in single family homes (risers supplying horizontal distribution paths), multi-family housing (horizontal distribution paths), and public facilities (horizontal distribution paths).

Platinum pipes can be successfully used in internal or external radiant heating or cooling systems, such as e.g. ice rinks, driveways, garages, corridors, terraces, stairs, etc.

Due to the warranty period extended to 15 years, the KAN-therm Push Platinum is recommended for the construction of piping in high-standard construction.

In accordance with EN ISO 21003-2, composite Platinum pipes can work within the below parameters:

Heating systems:

— $T_{op} / T_{max} = 80^{\circ}\text{C} / 90^{\circ}\text{C}$, $P_{op} = 10 \text{ bar}$

Water installations:

— $T_{op} / T_{max} = 60^{\circ}\text{C} / 80^{\circ}\text{C}$, $P_{op} = 10 \text{ bar}$

Due to its properties, KAN-therm Push Platinum may also be used to build a variety of non-standard piping systems, such as compressed air installations.

Installing KAN-therm Push Platinum for custom application requires a positive opinion of the KAN Technical Advisory Division.



Pipes

Easy installation

The PE-Xc/Al/PE-HD Platinum plastic pipes are manufactured as composite pipes, where the core is made of cross-linked polyethylene with the use of an electron beam - PE-Xc. The laser-welded aluminum layer prevents oxygen diffusion and greatly reduces the thermal expansion of the pipe.

The outer high-density polyethylene coating (PE-HD) protects the aluminum layer against mechanical damage.

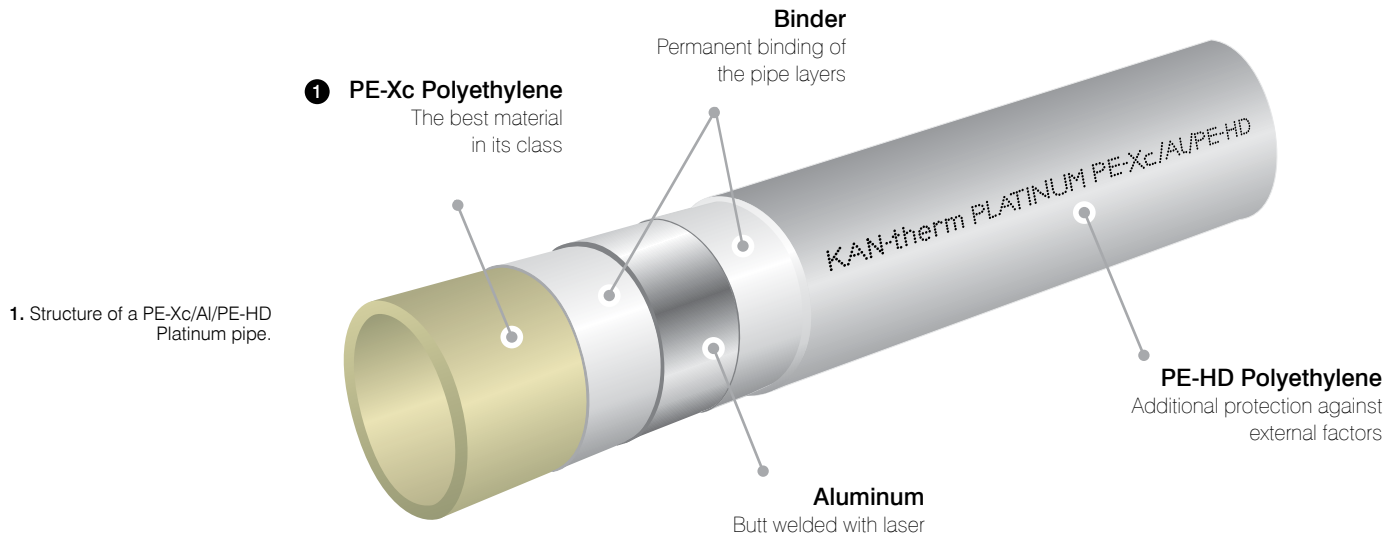

PE-Xc/Al/PE-HD Platinum pipes are available in diameter range between 14-32 mm and are delivered in 25, 50 or 200 m coils. The dimensions of Platinum pipes are adapted to standard fittings of the KAN-therm Push System.

PLATINUM PIPE SIZES

Nominal diameter	Pipe external diameter	Wall thickness	Dimensions of fittings	Internal diameter
DN	[mm]	[mm]	[mm]	[mm]
14	14	2,25	14x2	9,5
18	17	2,8	18x2,5	11,4
25	25	3,7	25x3,5	17,6
32	32	4,7	32x4,4	22,6

2. With its composite structure (PE-Xc/Al/PE-HD), Platinum pipes retain a given shape, are easier to install and are ideal for permanent arcs.

3. The bending radius of Platinum pipes $R = 5Dz$, using a spring to bend composite pipes $R = 3Dz$.

4. Coil of a KAN-therm Push Platinum pipe.





Fittings

Reliability

Connections within the diameter range of 14-32 mm in KAN-therm Push Platinum utilizes standard PPSU and brass fittings as well as brass KAN-therm Push sleeve to seal the connection.



KAN-therm Push & Seal™
Self-sealing connection
without o-rings

Reliability of individual connections as well as of the entire piping system is achieved due to the unique KAN-therm Push & Seal™ solution: a self-sealing connection without o-rings.

After putting the pipe on the connector and sliding on the sleeve, the seal is tightened - the system is ready for a leak test.

Tools

Professionalism

KAN-therm Push Platinum also involves a range of modern, professional tools to make connections.

The offer includes tools in the form of complete sets or individual elements:

- Cordless power tool sets by a recognized European brand, Novopress.
- Sets of foot-operated hydraulic tools by KAN-therm.
- Sets of manual chain tools by KAN-therm.



- Electric battery presses, hydraulic leg-operated presses, and manual chain presses as individual components.



- Manual or battery-operated expander and expanding heads for PE-Xc/Al/PE-HD Platinum pipes.



- Press inserts for plastic PPSU and brass fittings.



Tight and durable connections are ensured by professional, ergonomic, easy to use, and trouble-free tools, available in the KAN-therm Push Platinum offer.

Quick, easy and safe installation

Connecting elements of the KAN-therm Push Platinum system uses a simple, fast and above all, safe (no work with open fire) sleeve coupling technology (Push).

Tight connections without using o-rings are achieved by sliding a brass sleeve on to the connector and the pipe with the manual, hydraulic or battery press. Connections do not require additional seals, such as Teflon tape, tows.

1. Cut the pipe to the desired length using shears. The cut should be perpendicular to the pipe's axis.

2. Slide the sleeve's beveled internal end onto the pipe from the fitting.

3. Expand the pipes using a manual or battery expander.

4. Insert the connector into the pipe up to the last bead on the fitting.

5. Slide the sleeve on using a press, either manual, leg-operated hydraulic or battery-powered press.

6. Once the sleeve has been slid onto the flange of the fitting, the connection is ready for a pressure test.

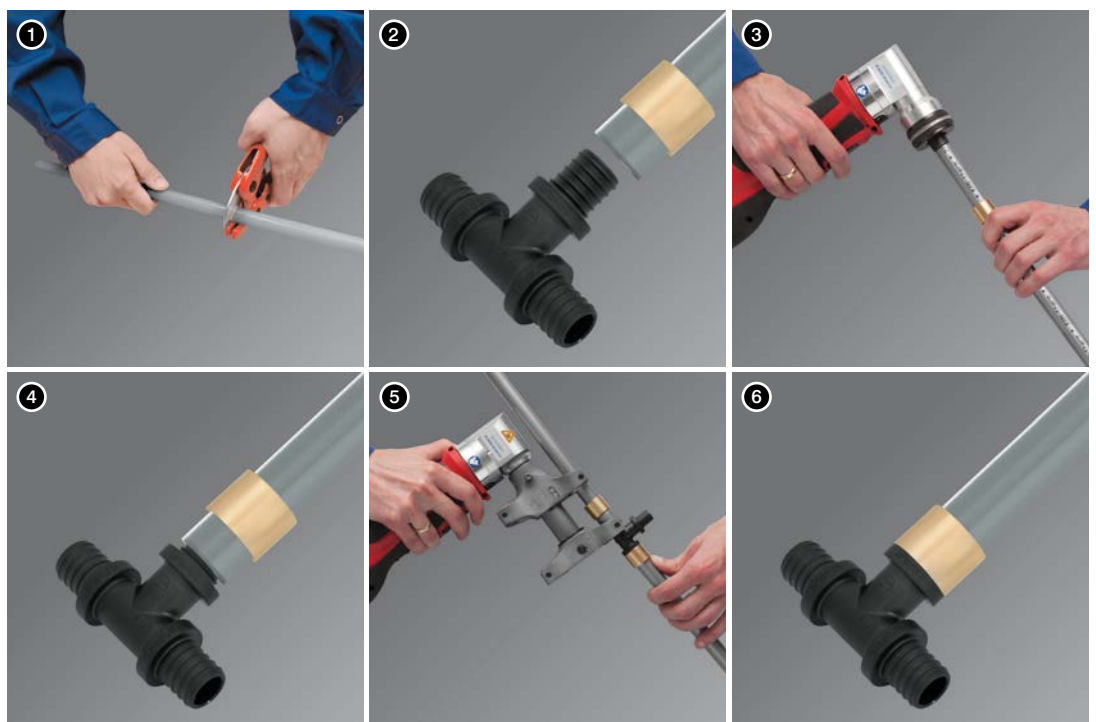

Durability

All system components are subject to continuous quality control and durability checks at every stage of their manufacture.

Prior to sending them to the warehouse, prefabricated components undergo final strict testing at the KAN lab.

By applying the latest techniques in the field of testing of piping systems, KAN Laboratory was accredited by Western certification bodies. All components are manufactured in accordance with EN ISO 21003, 22391, 15875 and have certificates and approvals of national and international certification bodies.

The high quality and durability of KAN-therm Push Platinum has been verified and confirmed at the international KAN certification lab using the test KAN-therm T50TM simulating 50 years of operation.

All components are manufactured in accordance with the following standards:

- **Push PPSU fittings: PN-EN ISO 15875 and PN-EN ISO 22391**
- **Push brass fittings: PN-EN 1254**
- **PE-Xc/Al/PE-HD Platinum pipes: PN-EN ISO 21003**

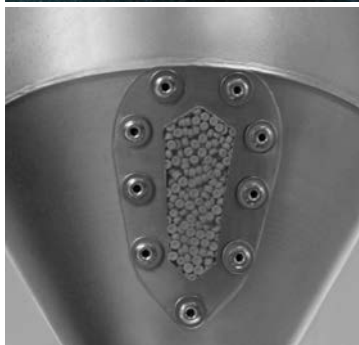
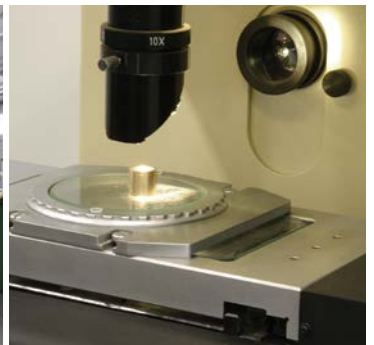



Safety and security

The high quality and durability of KAN-therm Push Platinum components is guaranteed for up to 15 years.

KAN-therm Push Platinum above all means reliability of properly made connections as well as security and guaranteed long-term, trouble-free operation.

Innovations in installation technology

Safety and security, reliability, durability, versatility and convenient installation are the advantages of KAN-therm Push Platinum, which have been recognized by the chapter of the 9th Instalexpo Congress, as evidenced by the award of the Golden Installer statue - a prestigious award given to distinguished sanitary products.

1. "Golden Installer 2011" statue awarded by the "Instalator Polski" magazine and the Polish Corporation of Sanitation, Heating, Gas and Air-Conditioning.
2. Golden Emblem at Quality International 2013, 2014, 2015. In the category QI Product for KAN-therm SYSTEM - top quality product.



1. Helipad on the roof of the Home Office Hospital - Olsztyn, Poland.



2. School dormitory - Augustów, Poland.

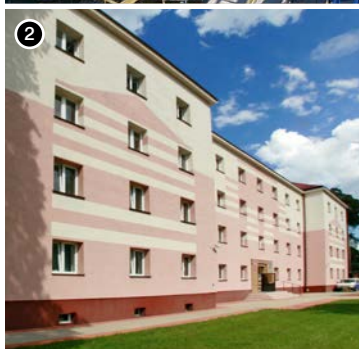

3. Monastery of the Annunciation of the Blessed Virgin Mary and St. John the Theologian - Supraśl, Poland.



SYSTEM **KAN-therm**

Optimal, complete multipurpose installation system consisting of state of the art, mutually complementary technical solutions for pipe water distribution installations, heating installations, as well as technological and fire extinguishing installations.

It is the materialization of a vision of a universal system, the fruit of extensive experience, the passion of KAN's constructors, strict quality control of our materials and final products, and vast knowledge of the market of installations to meet the requirements of energy efficient, sustainable construction.

	Push Platinum	
	Push	
	Press LBP	
	PP	
	Steel	
	Inox	
	Sprinkler	
	Underfloor heating and automation	
	Football Stadium installations	
	Cabinets and manifolds	



KAN Sp. z o.o.
ul. Zdrojowa 51, 16-001 Białystok-Kleosin
tel. +48 85 74 99 200, fax +48 85 74 99 201
e-mail: kan@kan-therm.com

www.kan-therm.com